

DUAL GENERAL PURPOSE OPERATIONAL AMPLIFIER

■ GENERAL DESCRIPTION

The NJM1458 is a monolithic pair of Internally Compensated High Performance Amplifiers, constructed using the New JRC Planar epitaxial process. They are intended for a wide range of analog applications where board space or weight is important. High common mode voltage range and absence of "latch-up" make the NJM1458 ideal for use as voltage followers. The high gain and wide range of operating voltage provides superior performance in integrator, summing amplifier and general feedback applications.

The NJM1458 is short-circuit protected and require no external components for frequency compensation. The internal 6 dB/octave roll-off insures stability in closed loop applications. For single amplifier performance, see the NJM741 data sheet.

■ PACKAGE OUTLINE

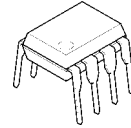

NJM1458D



NJM1458M

■ FEATURES

- Operating Voltage (+3V~+18V)
- Output Short-Circuit Protection
- Package Outline DIP8,DMP8
- Bipolar Technology

■ PIN CONFIGURATION

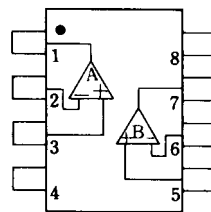

NJM1458D
NJM1458M

- PIN FUNCTION**
- 1.A OUTPUT
 - 2.A -INPUT
 - 3.A +INPUT
 - 4.V⁻
 - 5.B +INPUT
 - 6.B -INPUT
 - 7.B OUTPUT
 - 8.V⁺

■ EQUIVALENT CIRCUIT

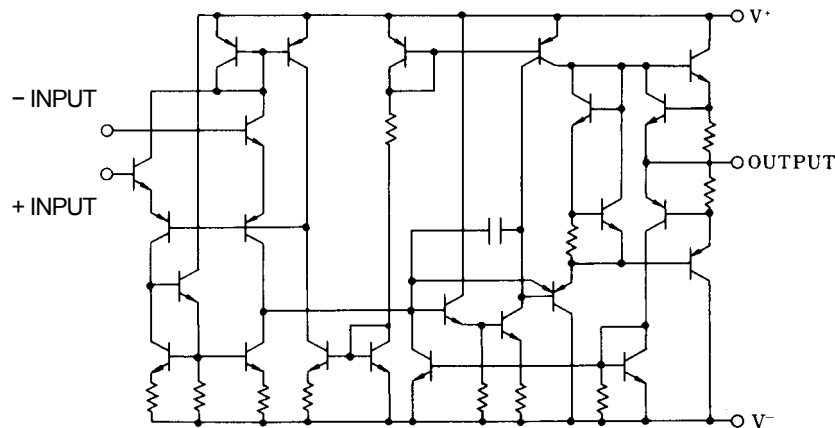

NJM1458

■ ABSOLUTE MAXIMUM RATINGS

(Ta=25°C)

PARAMETER	SYMBOL	RATINGS	UNIT
Supply Voltage	V^+ / V^-	± 18	V
Input Voltage	V_{IC}	± 15 (note)	V
Differential Input Voltage	V_{ID}	± 30	V
Power Dissipation	P_D	(DIP8) 500 (DMP8) 300	mW
Operating Temperature Range	T_{opr}	-40~+85	°C
Storage Temperature Range	T_{stg}	-40~+125	°C

(note) For supply voltage less than ±15V, the absolute maximum input voltage is equal to the supply voltage.

■ ELECTRICAL CHARACTERISTICS

(Ta=25°C, $V^+ / V^- = \pm 15V$)

PARAMETER	SYMBOL	TEST CONDITION	MIN.	TYP.	MAX.	UNIT
Input Offset Voltage	V_{IO}	$R_S \leq 10k\Omega$	-	2.0	6.0	mV
Input Offset Current	I_{IO}		-	5	200	nA
Input Bias Current	I_B		-	30	500	nA
Input Resistance	R_{IN}		0.3	1.0	-	MΩ
Large signal Voltage Gain	A_V	$R_L \geq 2k\Omega, V_O = \pm 10V$	86	106	-	dB
Maximum Output Voltage Swing 1	V_{OM1}	$R_L \geq 10k\Omega$	± 12	± 14	-	V
Maximum Output Voltage Swing 2	V_{OM2}	$R_L \geq 2k\Omega$	± 10	± 13	-	V
Input Common Mode Voltage Range	V_{ICM}		± 12	± 13	-	V
Common Mode Rejection Ratio	CMR	$R_S \leq 10k\Omega$	70	90	-	dB
Supply Voltage Rejection Ratio	SVR	$R_S \leq 10k\Omega$	76.5	90	-	dB
Operating Current	I_{CC}		-	3.3	5.7	mA
Slew Rate	SR	$R_L \geq 2k\Omega, A_V = 1$	-	0.5	-	V/μs
Channel Separation	CS	$f = 1kHz$	-	98	-	dB

■ TYPICAL CHARACTERISTICS

Operating Current vs. Temperature

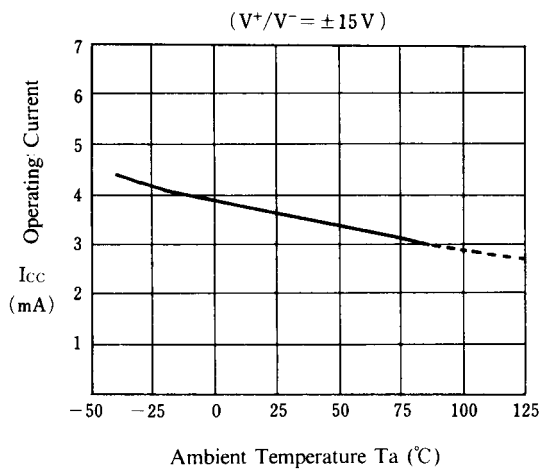

Input Offset Voltage vs. Temperature

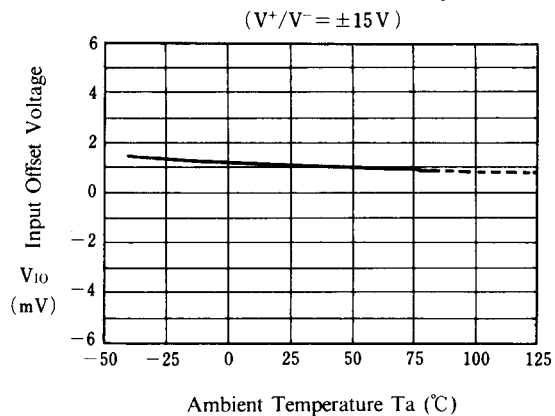

Maximum Output Voltage 1 vs. Temperature

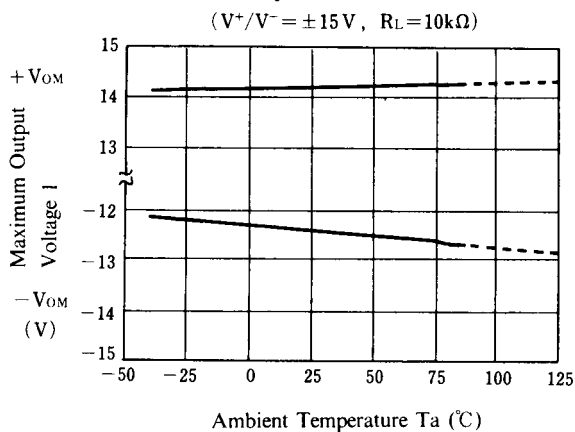

Maximum Output Voltage 2 vs. Temperature

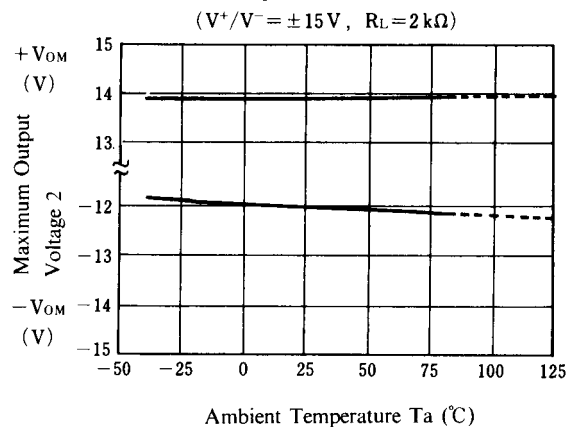

■ TYPICAL CHARACTERISTICS

Open Loop Frequency Response

($V^+/V^- = \pm 15V$, $T_a = 25^\circ C$)

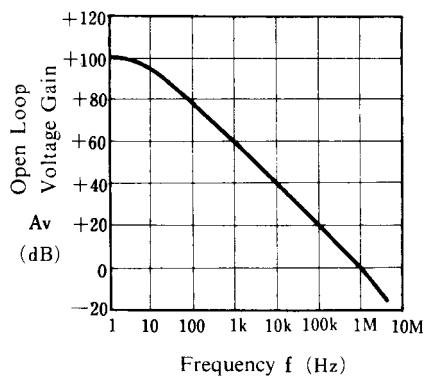

Maximum Output Voltage Swing vs. Frequency

($V^+/V^- = \pm 15V$, $T_a = 25^\circ C$)

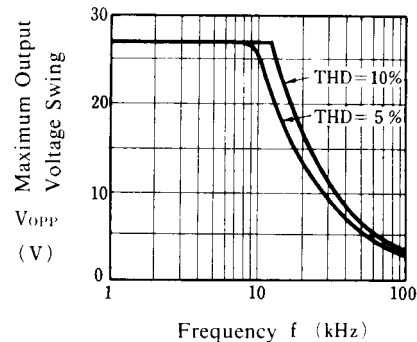

Maximum Output Voltage Swing vs. Load Resistance

($V^+/V^- = \pm 15V$, $T_a = 25^\circ C$)

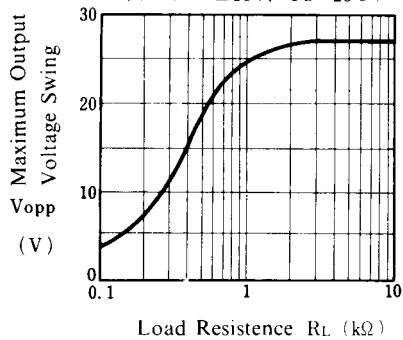

Input Bias Current vs. Temperature

($V^+/V^- = \pm 15V$)

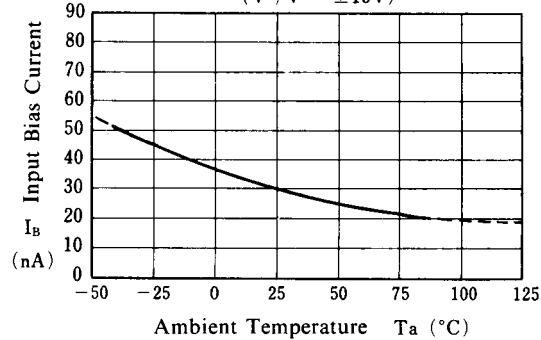

Maximum Output Voltage Swing vs. Operating Voltage

($R_L = 2k\Omega$, $T_a = 25^\circ C$)

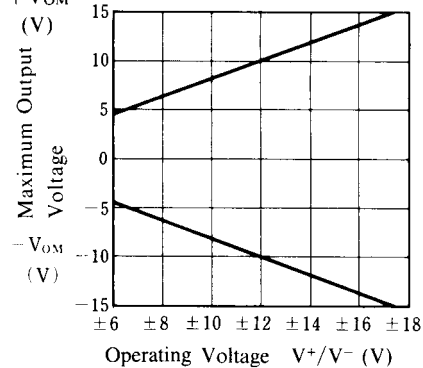

Input Bias Current vs. Operating Voltage

($R_s = 10k\Omega$, $T_a = 25^\circ C$)

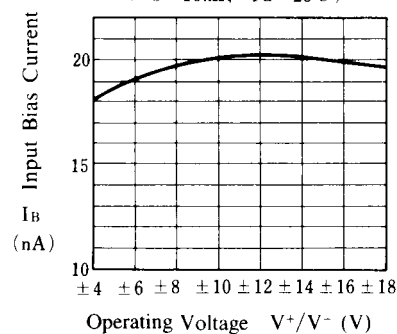

[CAUTION]

The specifications on this databook are only given for information, without any guarantee as regards either mistakes or omissions. The application circuits in this databook are described only to show representative usages of the product and not intended for the guarantee or permission of any right including the industrial rights.