

- High selectivity type ceramic filters
- Pass bandwidths from 30kHz to 4MHz
- Easily mounted to PCB
- Miniature size

## 4 Element

### SPECIFICATION

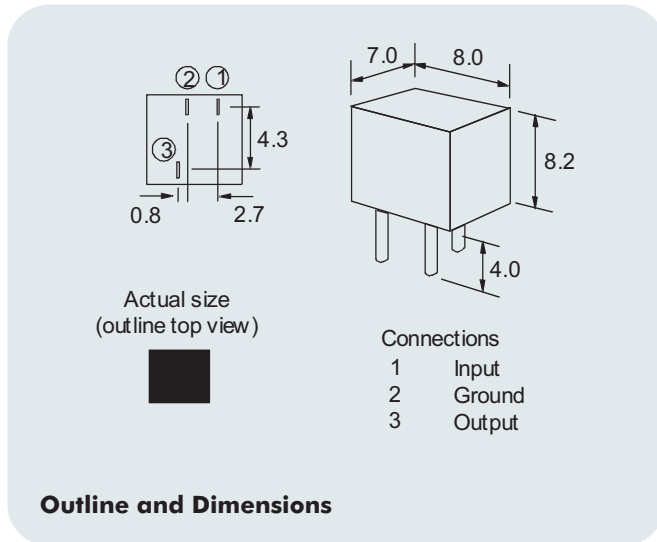

### Frequency v. Attenuation Characteristics

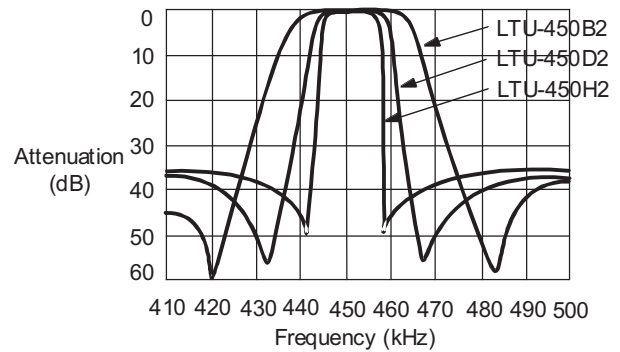

### ELECTRICAL CHARACTERISTICS

Part Number	Centre Frequency (kHz)	Insertion Loss (dB max.)	Pass Band Ripple (dB max.)	6dB Bandwidth (kHz min.)	40dB Bandwidth (kHz min.)	Stop Band Att. $\pm 100$ kHz (dB min.)	Input/Output Impedance ( $\Omega$ )
LTU-455B2	455 $\pm$ 2.0	4	2	$\pm 15$	$\pm 30$	27	1500
LTU-455C2	455 $\pm$ 2.0	4	2	$\pm 12.5$	$\pm 24$	27	1500
LTU-455D2	455 $\pm$ 1.5	4	2	$\pm 10$	$\pm 20$	27	1500
LTU-455E2	455 $\pm$ 1.5	6	2	$\pm 7.5$	$\pm 15$	27	1500
LTU-455F2	455 $\pm$ 1.5	6	2	$\pm 6$	$\pm 12.5$	27	2000
LTU-455G2	455 $\pm$ 1.0	6	2	$\pm 4.5$	$\pm 10$	25	2000
LTU-455H2	455 $\pm$ 1.0	6	2	$\pm 3$	$\pm 9$	25	2000
LTU-455I2	455 $\pm$ 1.0	6	2	$\pm 2$	$\pm 7.5$	25	2000
LTU-455HT	455 $\pm$ 1.0	6	2	$\pm 3$	$\pm 9$	35	2000
LTU-455IT	455 $\pm$ 1.0	6	2	$\pm 2$	$\pm 7.5$	35	2000

### TEST CIRCUIT

